

The integrated LED downlight range incorporates a driver. The range is easy to install and delivers high system efficacy of up to 76lm/w - producing 62% more light when compared to conventional plug-in tube downlights.

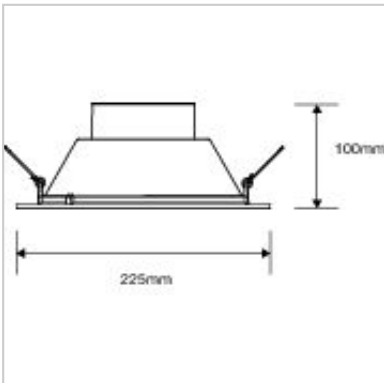

Class
I



35.5W Integrated Downlight 2800K

Product Code	517492
International Model Number	F27100RC
Description	35.5W Integrated LED Downlight
Watts	35.5W
Colour temperature / CRI	2800K / 80
Lumens	2700lm
Candelas	1420cd
Dimmable	N
Lamp life L70	50,000hr
Lamp life L90	25,000hr
Beam Angle	90
Weight	447g
Dimensions	94mm x 225 mm
IP Rating	IP44
Colour/Finish	White
Shape	Round
Hole cut out	200mm
Min Ceiling Depth	98mm
Operating Temperature	-30° to +40°

Last modified: 2016-11-16 10:19:02.

View online at <https://www.megamanuk.com/products/fixtures/led-integrated-downlights/517492/>

Megaman (UK) Limited, Megaman House, 2 Quadrant Park, Mundells, Welwyn Garden City, Herts, AL7 1FS
Telephone: +44 (0) 1707 386000 , **Email:** sales@megamanuk.com **Website:** www.megamanuk.com

