



**Instruction Manual**

**TECHNICAL SPECIFICATION**

	F50000SM	F50100SM	F50100SMv1	F50300SM	F50300SMv1
Model number	F50000SM	F50100SM	F50100SMv1	F50300SM	F50300SMv1
Wattage	19.5W	41.5W	22.5W	63W	35W
Voltage	220-240V~	220-240V~	220-240V~	220-240V~	220-240V~
Frequency	50/60Hz	50/60Hz	50/60Hz	50/60Hz	50/60Hz
Power factor	>0.9	>0.9	>0.9	>0.9	>0.9
IP rating	IP66	IP66	IP66	IP66	IP66
IK rating	IK08	IK08	IK08	IK08	IK08
Length	700mm	1300mm	1300mm	1600mm	1600mm
Maximum number of loop-through connection	63	30	55	19	35
Maximum length of cable* connection	410m	410m	410m	410m	410m

\*Remarks: including power cable and cable for inter-connecting MEGAMAN® DINO.

**PART LIST**

A1	A2	A3
Mounting Clips	Screw	Screw Raw Plug
		
2 pcs	2 pcs	2 pcs

**CAUTIONS**

- Read the entire manual carefully before installation and operation.
- It is recommended that the installation or replacement be performed by a licensed and qualified electrician.
- Before installation, replacement and cleaning of the luminaire, turn it off and allow it to cool down. Heat-resistant gloves are mandatory when handling the luminaire.
- The suggested installation height is above 2.5m and the minimum safety distance

**ATTENTION**

- Instant start is allowed.
- Designed for indoor and outdoor applications.
- The operating temperature is -30°C to +40°C.
- To optimise the waterproof performance, it is recommended to use oil resistant rubber cable (power cable), H07RN-F/2G1.5.

- from the illuminated object is 0.1m. 
- The luminaire is not suitable to be used in dimmer circuits.
- The manufacturer accepts no liability for any damage resulting from the misuse of the luminaire or from when it is used with inappropriate equipment.
- Consult your dealer if you have any enquiries.

- If the external flexible cable of the luminaire is damaged, it should be replaced by a licensed and qualified electrician to avoid any accidents.
- **DO NOT REMOVE** the plastic clip on the MEGAMAN® DINO.
- **NO EARTH** function when DINO are loop-through connection.

**Connection**

• Remove the plate of waterproof socket by turning anti-clockwise.

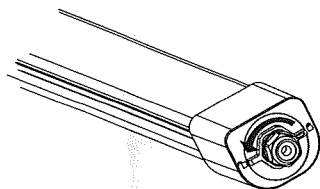

Step1

• Unscrew the waterproof socket. Pass the power cable through the waterproof socket and connect the wire to the terminal block as shown below.

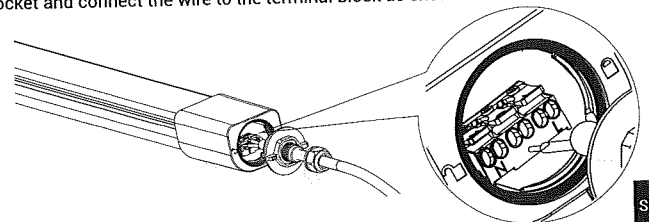

Step2

• Place the plate of the waterproof socket to the luminaire. There is arrow mark (⇔) on the plate, it should point toward the unlock mark (↻) on the luminaire.

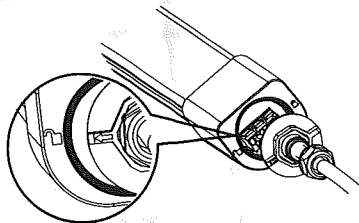

Step3

• Turn clockwise to lock the plate to the luminaire. The arrow mark (⇔) of the plate should point to lock mark (⊞) when it is securely locked.

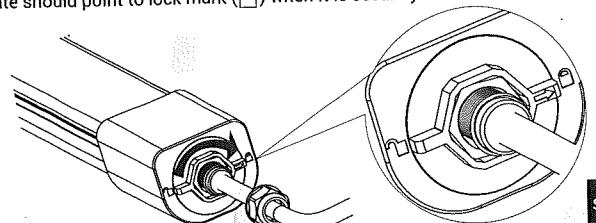

Step4

• To ensure the luminaire has the waterproof protection, the waterproof socket should be screw properly with minimum force of 1.2Nm.

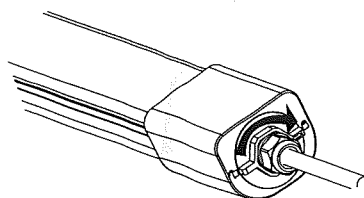

Step5

## Multiple Connections

- The inter-connecting cable can be used to connect two MEGAMAN® DINO together. It is similar to the connection of power cable, please refer to Step 1 to Step 5 of "Connection" to connect the inter-connecting cable to the first MEGAMAN® DINO.
- Use the same inter-connecting cable and repeat Step 1 to Step 5 of "Connection" to connect the second MEGAMAN® DINO. Please refer to the following diagrams.

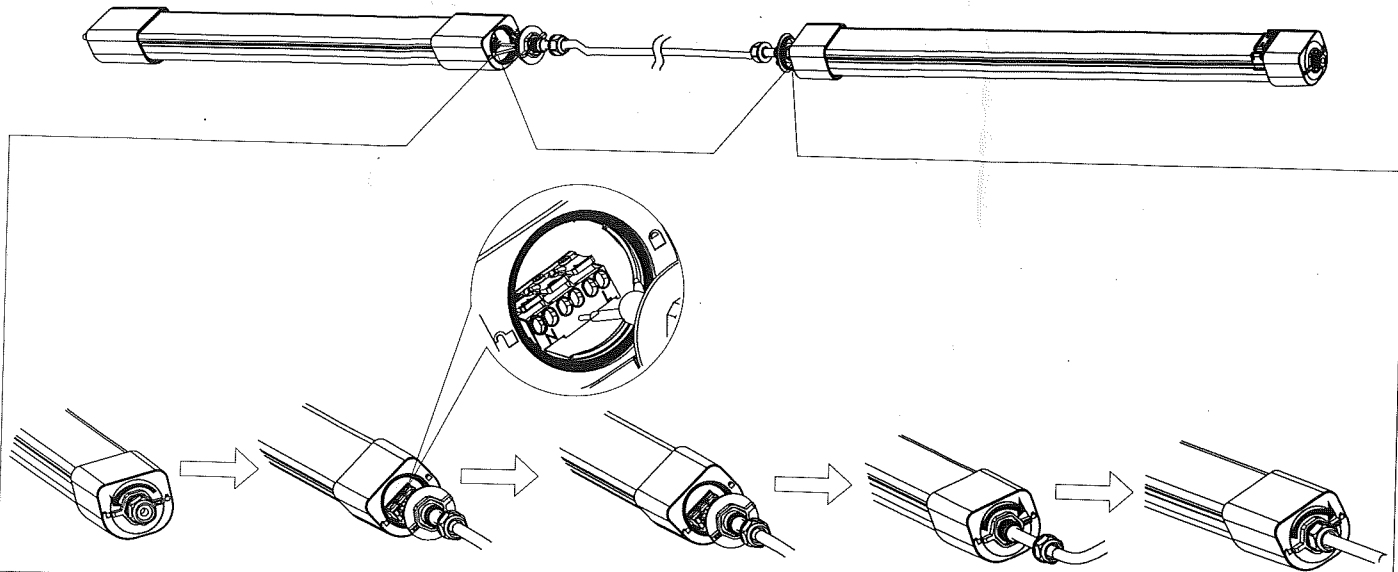

## Installation

- Fasten the mounting clips (A1), to wall or ceiling surface with the screw (A2) and screw raw plug (A3).

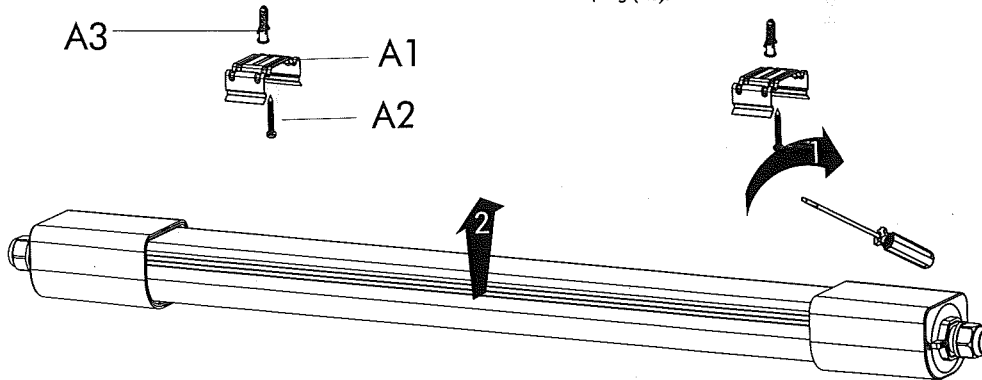

- Suggested distance between the mounting clips:

The length of MEGAMAN® DINO	Distance for B1 (mm)	Distance for B2 (mm)
700mm	172~197	305~355

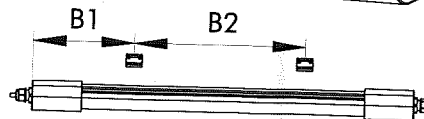

The length of MEGAMAN® DINO	Distance for C1 (mm)	Distance for C2 (mm)
1300mm	172~197	905~955

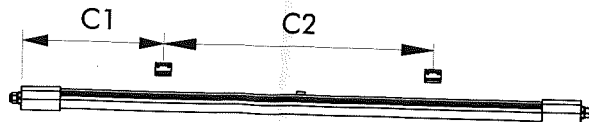

The length of MEGAMAN® DINO	Distance for D1 (mm)	Distance for D2 (mm)
1600mm	172~197	1205~1255

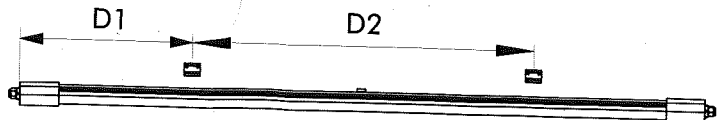

### Correct Disposal of This Product

This marking indicates that this product should not be disposed with other household wastes throughout the EU. To prevent possible harm to the environment or human health from uncontrolled waste disposal, recycle it responsibly to promote the sustainable reuse of material resources. To return your used device, please use the return and collection systems or contact the retailer where the product was purchased. They can take this product for environmental safe recycling.

**Neonlite Electronic & Lighting (HK) Ltd.**  
31/F, AIA Kowloon Tower, Landmark East, 100 How Ming Street,  
Kwun Tong, Kowloon, Hong Kong.

MEGAMAN®

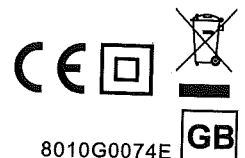

8010G0074E